

Call transfer

Attended transfer:

1. Press **[Xfer]** key or Xfer soft key during the active conversation, the call is put on hold.
2. Dial the second telephone number.
3. When the call is answered, then press **[Xfer]** key or Xfer soft key to complete the operation.

Blind transfer:

1. Press **[Xfer]** key or Xfer soft key during the active conversation, the call will be on hold.
2. Then enter the 2nd telephone number and press **[Xfer]** key or Xfer soft key.

Call forward

1. Press Menu > Features > Call Forward.
2. Select the line, the type of forward, enter the destination number and status and OK.

Call Mute

1. Press **[Mute]** to Mute the microphone during the call.
2. Press **[Mute]** again to un-mute the conversation.

Call list

1. Press **[Call Log]** key or Menu > CallLog > Local Call Logs.
2. Scroll through the list using **[Up]** or **[Down]**.
3. To dial an entry, press Dial soft key or pickup handset or press **[Call]** or **[Handset]**.

Phonebook

Access phonebook:

1. Press **[Contacts]** or Contact soft key or Menu > Dir > Local Contacts.
2. Select All Contacts or other group.
3. To dial an entry, press Dial soft key or pickup handset or press **[Call]** or **[Handset]**.

Add new entry:

1. Press Contact soft key, Press All Contacts or other group > Press Add.
2. Enter name and number and press OK soft key.

Programmable keys

1. You can configure shortcuts for the programmable keys.
2. Press Menu > Basic > Keyboard, select among the configurable items, and select your desired type and value, press OK key.

Redial

1. Press **[Redial]** redial a call number.

Do not disturb

1. Press DND soft key, and enable the device do not disturb mode.
2. Or press Menu > Features > DND, and select the Mode and Type, and press OK soft key.

Voice mail

1. To access your voice mailbox, press **[Voice Mail]** or Menu > Message > Voice Message, number of messages will be indicated if provided by your server or pbx.
2. Select the line and press Play to call.

Fanvil

V1.1

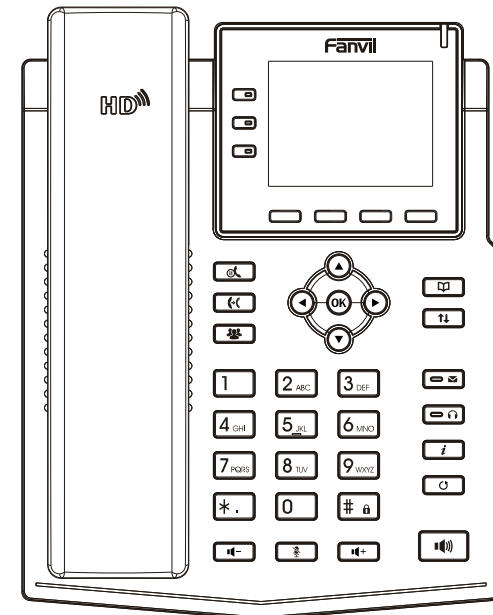

X3U

Quick Installation Guide

Fanvil Technology Co., Ltd

Website: www.fanvil.com

Email: sales@fanvil.com support@fanvil.com

Tel: +86-755-2640-2199 Fax: +86-755-2640-2618

Add: 10/F Block A, Dualshine Global Science Innovation Center,
Honglang North 2nd Road, Bao'an District, Shenzhen, China

Fanvil Technology Co., Ltd
www.fanvil.com

P/N:CJBA100051B0

Packaging list

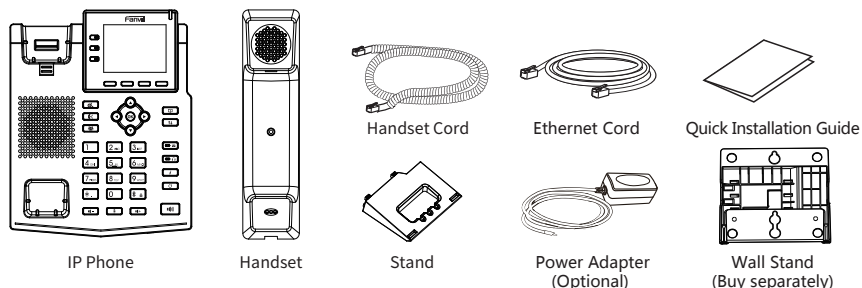

Screen icon

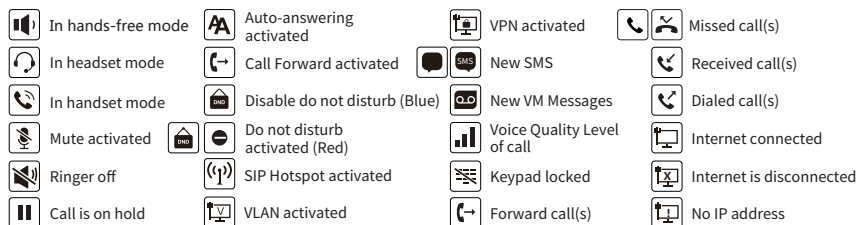

Keys features

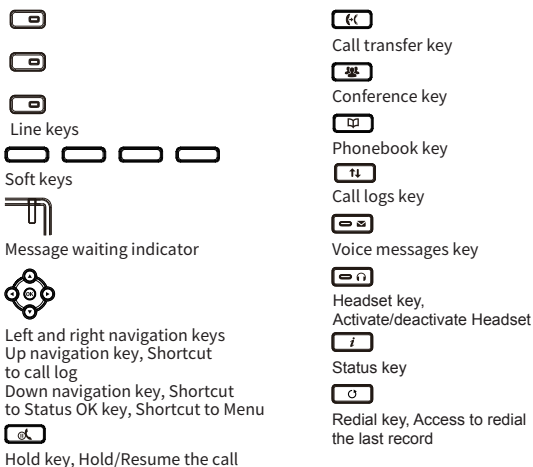

Installation the device

Please follow the instructions in below picture to install the device.

• Bracket desktop installation

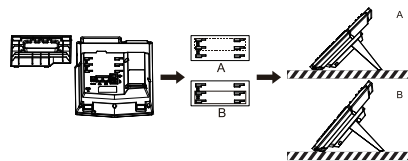

• Wall mounting (Wall Stand need buy separately)

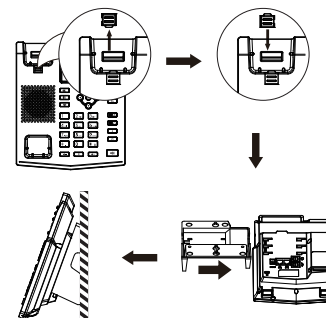

Connecting to the Device

Please connect power adapter, network, PC, handset, and headset to the corresponding ports as described in below picture.

- ① Power port: connect the power adapter.
- ② Network port: connecting local area network or Internet.
- ③ PC port: the network port connect to the computer.
- ④ Headset port: connect headset.
- ⑤ Handset port: connect IP Phone handset.

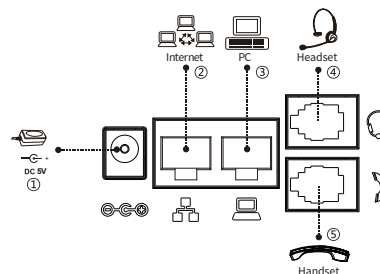

Configuration

Configuration via Phone

1. Press Menu > System (Default password 123)
2. Select Network: To configure the Network Settings (IPv4/IPv6/IPv4&IPv6, DHCP/Static/PPPoE)
3. Select Accounts: To configure enable the account, fill the SIP server address, port, user name, password etc.

Configuration via Web

1. Get the IP address from the phone: Press key, or Menu > Status > IPv4 / IPv6.
2. Login: Input the IP address in the web browser. The PC and phone should be in the same IP address segment (The default username and password are both 'admin').
3. Configure: Select network/Account etc, and fill the relevant content.
4. Save the configuration.

Language setting

1. Press Menu key > Basic > Language.
2. Select the desired language and press OK soft key.

Making a call

1. **Pre-dialing:** enter the phone number and pick up the handset.
2. **Direct dialing:** lift the handset and enter the phone number.
3. **Handsfree:** enter phone number and press or vice versa.
4. **Headset:** enter phone number and press or vice versa.
5. **Designated line:** press line key, enter phone number and press dial key.

Accepting a call

1. **With the handset:** pick up the handset.
2. **With a headset:** press .
3. **With the handsfree:** press .

Putting a call on hold

1. Press key or Hold soft key, caller is put on hold.
2. To retrieve the call press key or Resume soft key.
Note: with more than one active call, select desired call with the navigator keys and use the corresponding soft key to hold or resume.

3-party conference

1. Once in line with 1st caller, press key or Conf soft key, 1st caller is put on hold.
2. Then call the 2nd number.
3. After, 2nd call is established, press key or Conf soft key to set up the conference.